

Article number: 09066620

Description: KLEE Feather keys B 6x6x20 DIN 6885

Measures

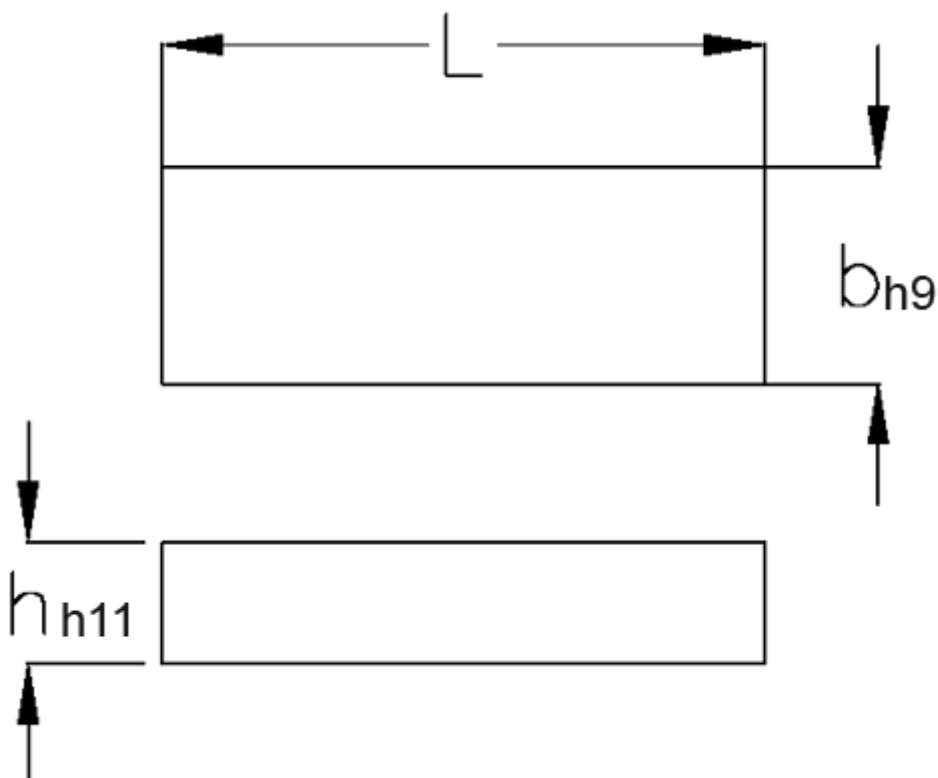

b	= 6
h	= 6
L	= 20
Tolerance b	= 0.030
Tolerance h	= 0.075
Tolerance L	= -0,3